

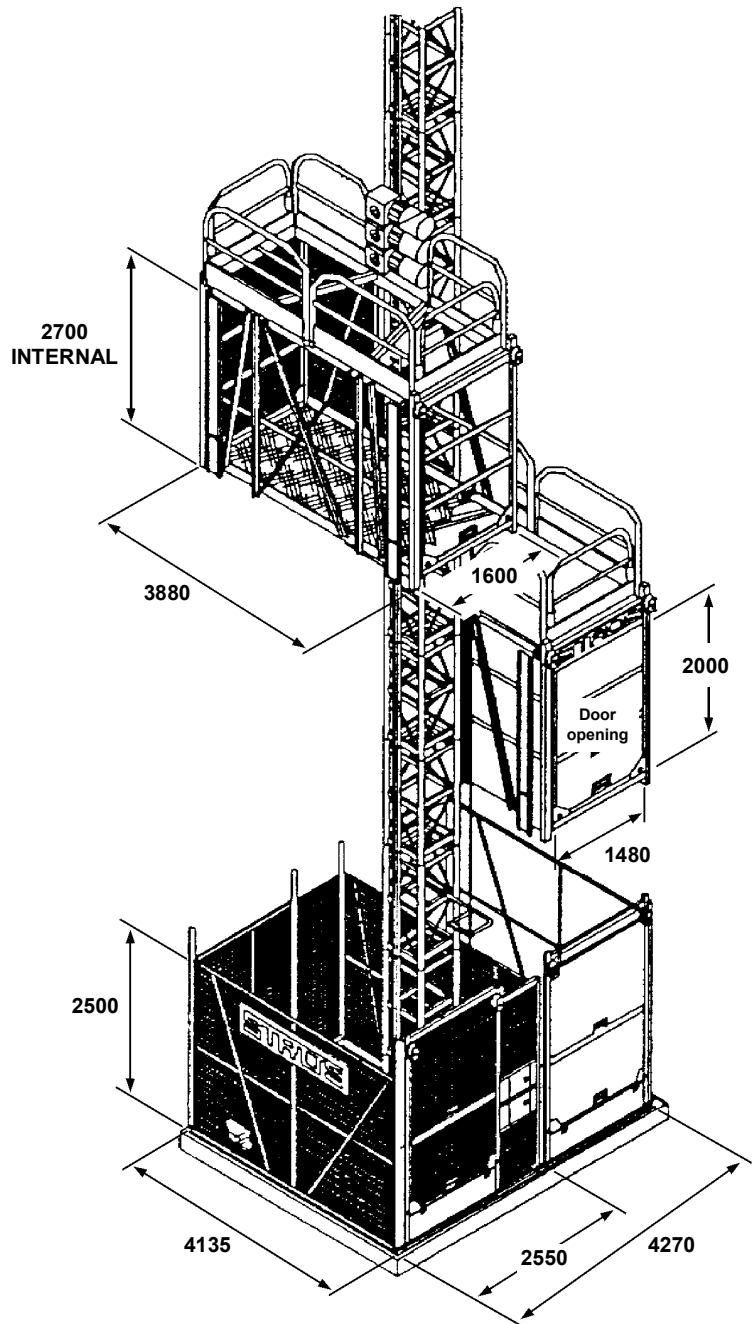

STROS 20/38 TD PASSENGER GOODS HOIST

HOIST SPECIFICATIONS	
Capacity	2000kg (24 people)
Internal Cage Length	3.8m
Internal Cage Width	1.5m
Speed	33m/min
Voltage	415V 3 phase
Power Cont. Duty	3 x 7.5kW
Starting Current	310A
Power Consumption	49kVA
Power Supply Fuses (HRC)	80A
Base Unit Weight	3500kg
Max. Freestanding Landing Height	8m
Max. Tie Interval	12m
Max. Tie Oversail	9m
Max. Final Landing Height	146m



LONDON
HOIST
LTD

RIFLE STREET - LONDON - E14 6PB
TEL : 0207 5384833 - FAX : 0207 5153593
www.londonhoist.co.uk - info@londonhoist.co.uk

04-2003